



### Typical Applications

The HMC865LC3C is ideal for:

- 100 Gbps Ethernet
- 100 Gbps Long Haul
- 40 Gbps (D)QPSK Receivers
- Broadband Gain Block for Test & Measurement Equipment

### Features

- Supports Data Rates up to 43 Gbps.
- Low Power Dissipation: 300 mW @  $V_{cc} = +3.3V$
- Differential Small Signal Gain: 30 dB
- High Input Sensitivity: 10 mVp-p Differential
- 3-dB Bandwidth: 26.5 GHz
- Adjustable Output Voltage Swing up to 800 mVp-p Differential
- 16 Lead 3x3mm SMT package: 9mm<sup>2</sup>

### Functional Diagram

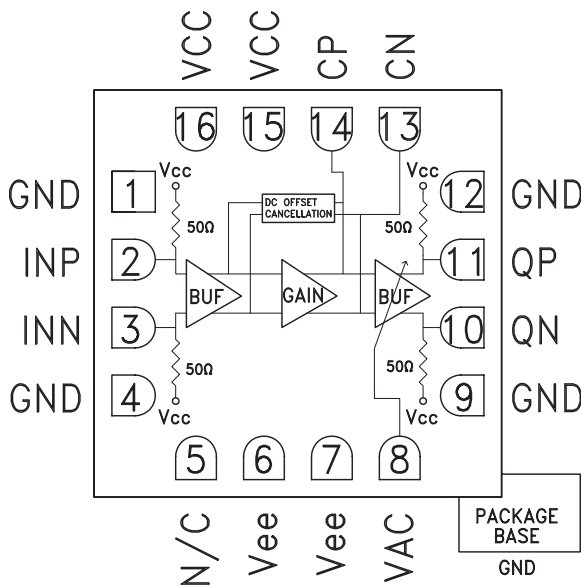

### General Description

The HMC865LC3C is a Limiting Amplifier packaged in a leadless 3x3 mm ceramic surface mount package which supports up to 43 Gbps operation. The amplifier provides 30 dB of differential gain. Output voltage swing is adjustable up to 800 mVp-p differential by using the VAC analog control input. Additive rms jitter is less than 300 fs for 32 Gbps operation. HMC865LC3C has an internal DC offset correction circuit which provides differential 10 mVpp input sensitivity.

All input/output RF signals of the HMC865LC3C are terminated with 50 Ohms to +3.3V on chip and may be either AC or DC coupled. The outputs of the device can be operated either differentially or single-ended. Outputs can be connected directly to 50 Ohm terminated system referenced to 3.3V, while DC blocking capacitors may be used if the terminating system is 50 Ohms to a non 3.3V level.

### Electrical Specifications, $T_A = +25\text{ }^\circ\text{C}$ , $V_{cc} = +3.3V$ , $V_{ee} = 0V$ , $I_{cc} = 90mA$

Parameter	Conditions	Min.	Typ.	Max.	Units
Differential Small Signal Gain	$V_{AC} = 1.6V$		30		dB
Data Rate		32			Gbps
Small Signal Bandwidth	3-dB cutoff		26.5		GHz
Input Return Loss	Up to 26.5 GHz	10			dB
Output Return Loss	Up to 26.5 GHz	10			dB
Input Sensitivity	Differential		10		mVp-p
Maximum Input Swing	Differential		1,000		mVp-p
Differential Output Swing	Adjustable by using VAC	250		800	mVp-p
Rise Time [1]	20% - 80% @ 32 Gbps		13		ps

[1]  $V_{in}$  = Differential 50 mVp-p,  $f_{in}$  = 32 Gbps PRBS 2<sup>23</sup>-1 pattern



**Electrical Specifications** (Conditions)

Parameter	Conditions	Min.	Typ.	Max.	Units
Fall Time [1]	20% - 80% @ 32 Gbps		13		ps
Additive Random Jitter [2]	Vin = 50 mVp-p (Differential)			300	fs
Input referred voltage noise	@ 15 GHz @ 25 GHz		31 32		nV/rtHz nV/rtHz
VAC		1		1.6	V
Output P1dB	@ 16 GHz		-6		dBm
Power Supply Voltage		3.13	3.3	3.47	V
Supply Current	VAC = 1.6V		90		mA
Operating Temperature		-40	25	85	°C
Low Frequency Cut-Off	100 nF off chip capacitor is used		10		kHz

[1] Vin = Differential 50 mVp-p, fin = 32 Gbps PRBS 2<sup>23</sup>-1 pattern

[2] Random jitter is measured with 32 Gbps 10101... pattern

**Differential Gain & Return Loss vs. Frequency** [1][2]

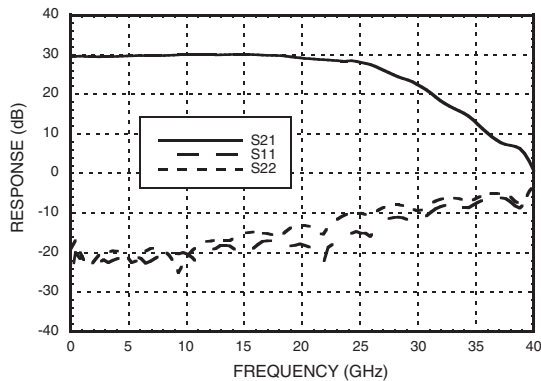

**Differential Output vs. Supply Voltage** [1]

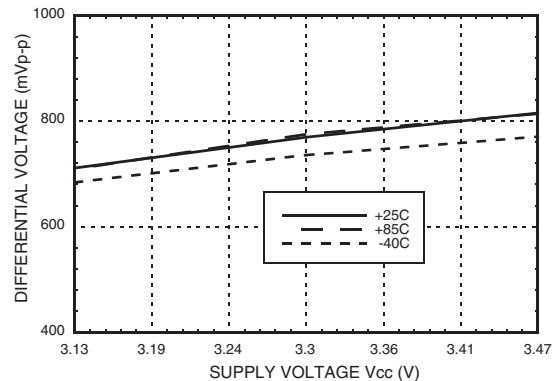

**Differential Output vs. Control Voltage** [2]

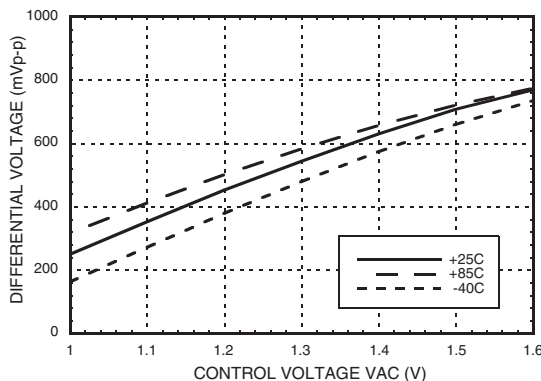

**Differential Output vs. Vin & Temperature @ 16 GHz** [1][2]

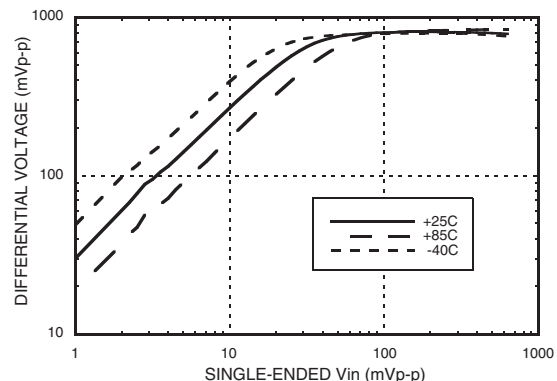

[1] VAC = 1.6V [2] Vcc = 3.3V



## 32 Gbps LIMITING AMPLIFIER

**Differential Output vs. Vininput & Supply Voltage @ 16 GHz [1]**

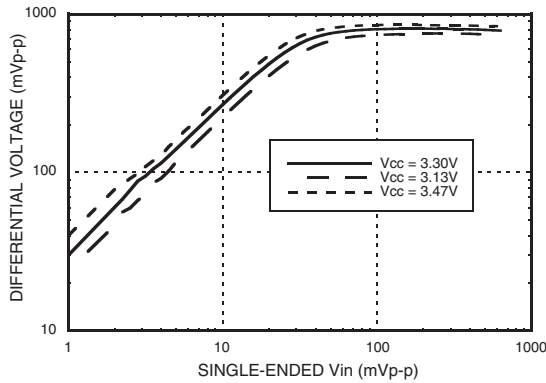

**Differential Output vs. Vininput & Frequency [1] [2]**

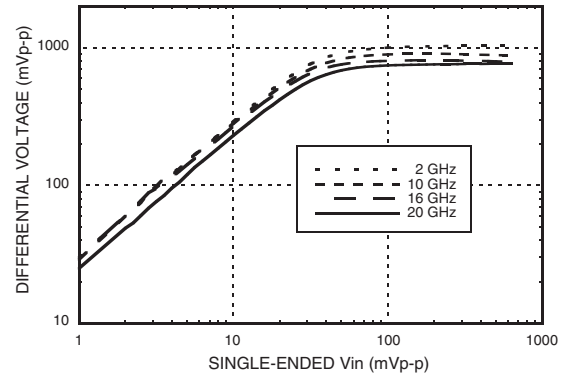

**Peak to Peak Jitter vs. Supply Voltage [1][3]**

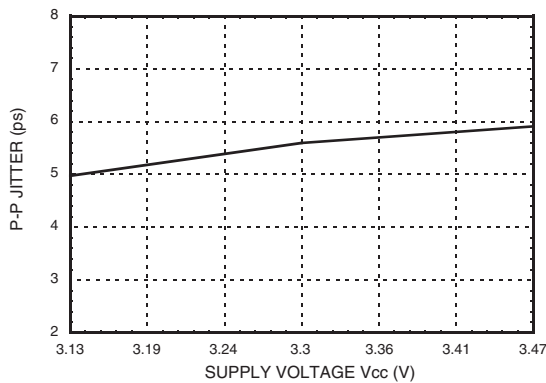

**Rise & Fall Time vs. Supply Voltage [1][3]**

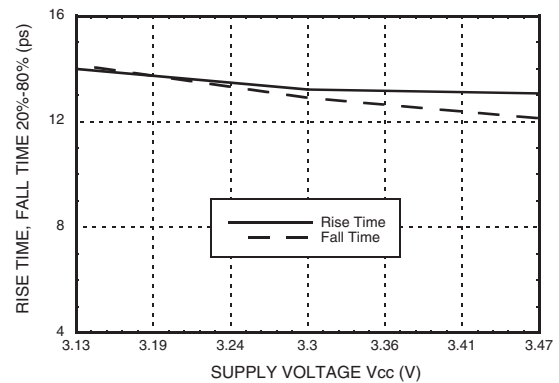

**DC Current vs. Supply Voltage [1][3]**

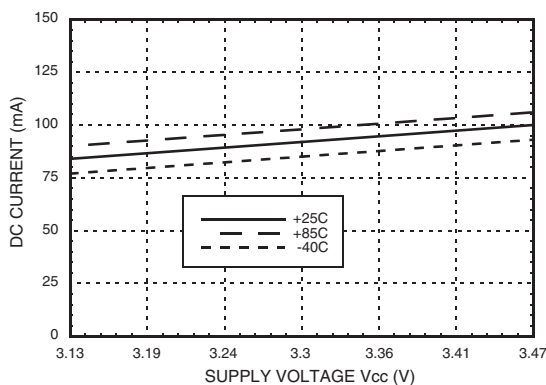

**DC Current vs. Control Voltage [2][3]**

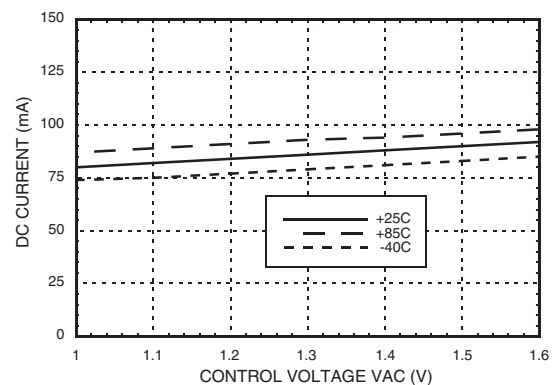

[1] VAC = 1.6V [2] Vcc = 3.3V [3] Input Data: Differential 50 mVp-p 32 Gbps NRZ PRBS 2<sup>23</sup>-1 pattern

## 32 Gbps LIMITING AMPLIFIER

### 32 Gbps Single-Ended Output Eye Diagram

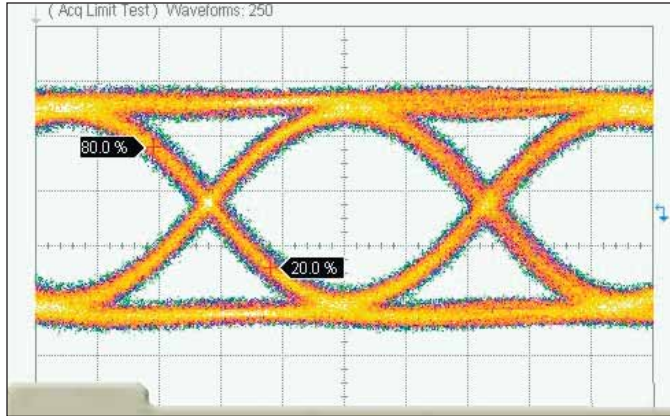

Measurements				
	Current	Minimum	Maximum	Total Meas
Eye Amp	362 mV	361 mV	362 mV	63
Jitter p-p	4.978 ps	4.822 ps	5.444 ps	63
Rise Time	13.84 ps	13.84 ps	14.00 ps	63
Fall Time	13.22 ps	11.20 ps	13.53 ps	63

Time Scale: 7 ps/div  
Amplitude Scale: 100 mV/div

Test Conditions:

VAC = 1.6V, Vcc = 3.3V  
Input Data: Differential 50 mVp-p 32 Gbps NRZ PRBS 2<sup>23</sup>-1 pattern

### 22.5 Gbps Single-Ended Output Eye Diagram

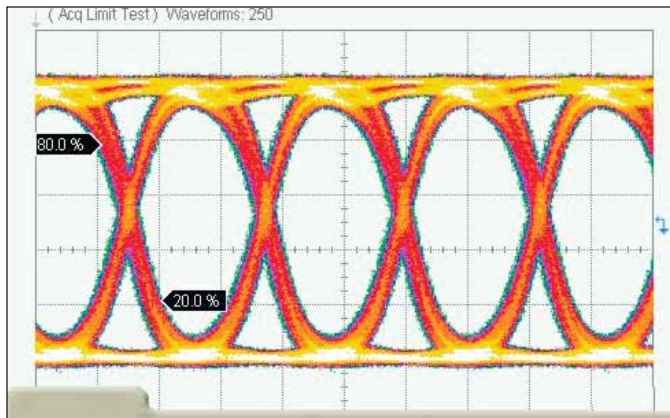

Measurements				
	Current	Minimum	Maximum	Total Meas
Eye Amp	388 mV	387 mV	388 mV	83
Jitter p-p	8.000 ps	5.778 ps	8.000 ps	83
Rise Time	14.22 ps	13.78 ps	14.67 ps	83
Fall Time	13.78 ps	13.33 ps	13.78 ps	83

Time Scale: 20 ps/div  
Amplitude Scale: 81.6 mV/div

Test Conditions:

VAC = 1.6V, Vcc = 3.3V  
Input Data: Differential 50 mVp-p 22.5 Gbps NRZ PRBS 2<sup>23</sup>-1 pattern

### 40 Gbps Single-Ended Output Eye Diagram

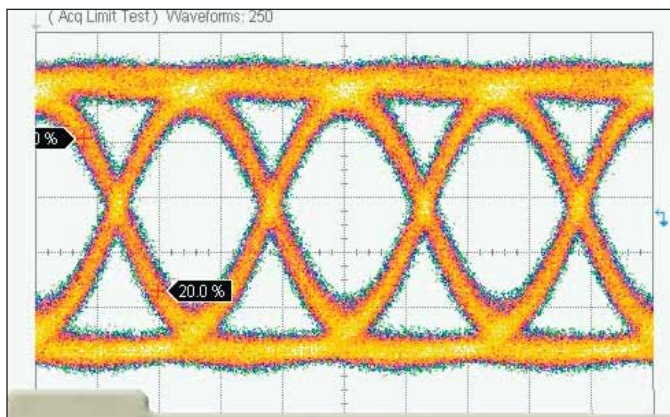

Measurements				
	Current	Minimum	Maximum	Total Meas
Eye Amp	352 mV	352 mV	352 mV	60
Jitter p-p	5.333 ps	4.444 ps	5.333 ps	60
Rise Time	11.78 ps	11.33 ps	12.00 ps	60
Fall Time	12.00 ps	11.56 ps	12.00 ps	60

Time Scale: 10 ps/div  
Amplitude Scale: 80.1 mV/div

Test Conditions:

VAC = 1.6V, Vcc = 3.3V  
Input Data: Differential 80 mVp-p 40 Gbps NRZ PRBS 2<sup>23</sup>-1 pattern



**32 Gbps Input & Output Eye Diagrams**

**Input Signal**

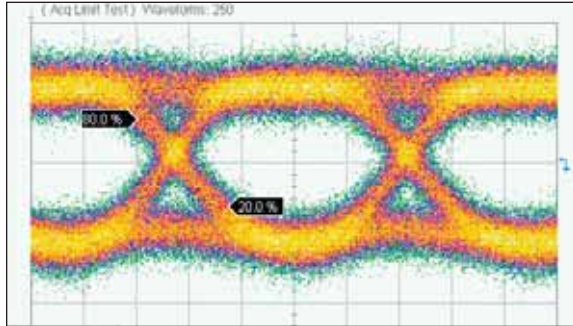

	Current	Minimum	Maximum	Total Meas
Eye Amp	9.27 mV	9.25 mV	9.27 mV	36
Jitter p-p	10.733 ps	7.933 ps	10.733 ps	51
Rise Time	8.56 ps	8.24 ps	40.13 ps	51
Fall Time	10.11 ps	4.04 ps	10.27 ps	51

Time Scale: 7 ps/div  
Amplitude Scale: 2.8 mV/div

Test Conditions:

VAC = 1.6V, Vcc = 3.3V

**Output Signal**

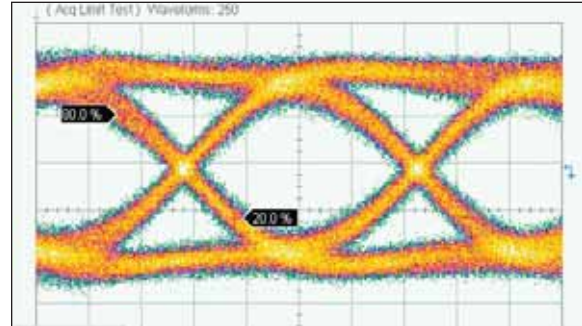

	Current	Minimum	Maximum	Total Meas
Eye Amp	219 mV	219 mV	220 mV	55
Jitter p-p	5.444 ps	4.822 ps	5.444 ps	55
Rise Time	11.93 ps	14.78 ps	15.40 ps	55
Fall Time	14.78 ps	14.78 ps	15.40 ps	55

Time Scale: 7 ps/div  
Amplitude Scale: 60 mV/div

Test Conditions:

VAC = 1.6V, Vcc = 3.3V

**Absolute Maximum Ratings**

Power Supply Voltage (Vcc)	-0.5V to +3.6V
Input Voltage	(Vcc -1.3V) to (Vcc +0.5)
Output Voltage	(Vcc -1V) to (Vcc +0.5)
Output Amplitude Control Voltage (VAC)	-0.5V to +2.5V
Junction Temperature	125 °C
Continuous Pdiss (T = 85°C) (Derate 13.10 mW/°C above 85°C)	0.52W
Thermal Resistance (R <sub>th</sub> ) (junction to ground paddle)	76.32 °C/W
Storage Temperature	-65 to 125 °C
Operating Temperature	-40 to +85 °C



**ELECTROSTATIC SENSITIVE DEVICE  
OBSERVE HANDLING PRECAUTIONS**



### Outline Drawing

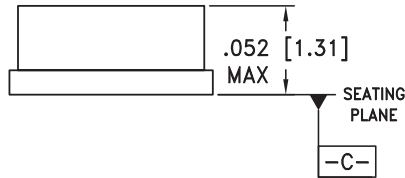
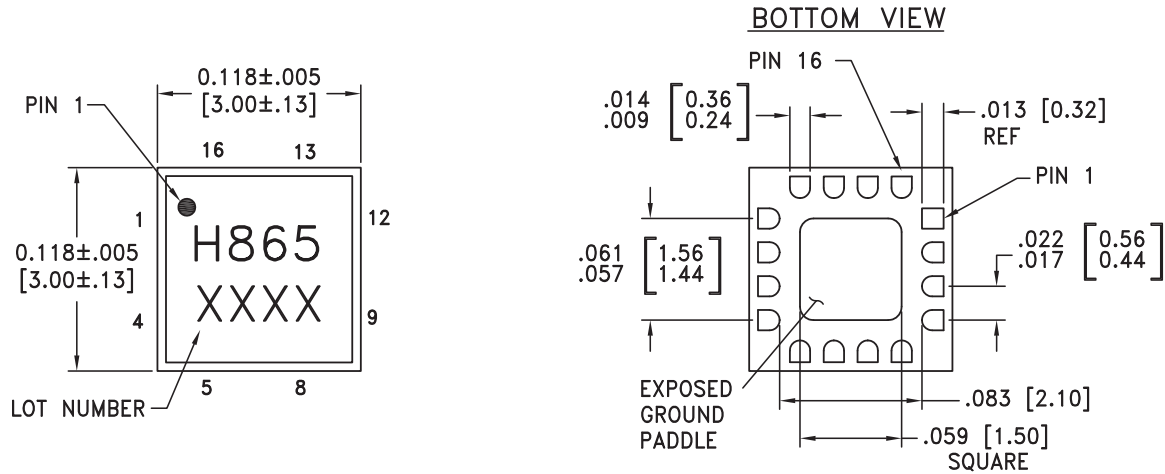

**NOTES:**

1. PACKAGE BODY MATERIAL: ALUMINA
2. LEAD AND GROUND PADDLE PLATING:  
30-80 MICROINCHES GOLD OVER 50 MICROINCHES MINIMUM NICKEL.
3. DIMENSIONS ARE IN INCHES [MILLIMETERS].
4. LEAD SPACING TOLERANCE IS NON-CUMULATIVE.
5. PACKAGE WARP SHALL NOT EXCEED 0.05mm DATUM -C-
6. ALL GROUND LEADS MUST BE SOLDERED TO PCB RF GROUND.
7. PADDLE MUST NOT BE DC GND. THERMAL DISSIPATION PATH ONLY.

### Pin Descriptions

Pin Number	Function	Description	Interface Schematic
1, 4, 9, 12	GND	Signal grounds should be connected to 0V.	
2, 3	INP, INN	Data Inputs	
6, 7	Vee	Supply grounds should be connected to 0V.	

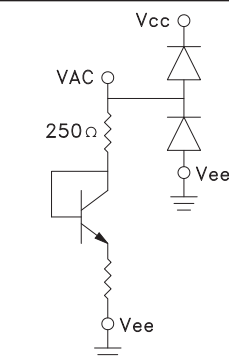
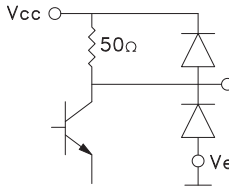
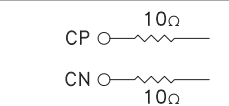
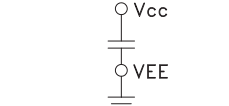
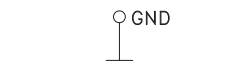

Pin Descriptions (Continued)

Pin Number	Function	Description	Interface Schematic
8	VAC	Output amplitude control voltage	
10, 11	QN, QP	Data outputs.	
13, 14	CN, CP	Filter capacitor for offset correction. Connect 100nF capacitor between CP and CN	
15, 16	Vcc	Positive Supply	
Ground Paddle	GND	Ground paddle must be connected to DC ground.	



**Evaluation PCB**

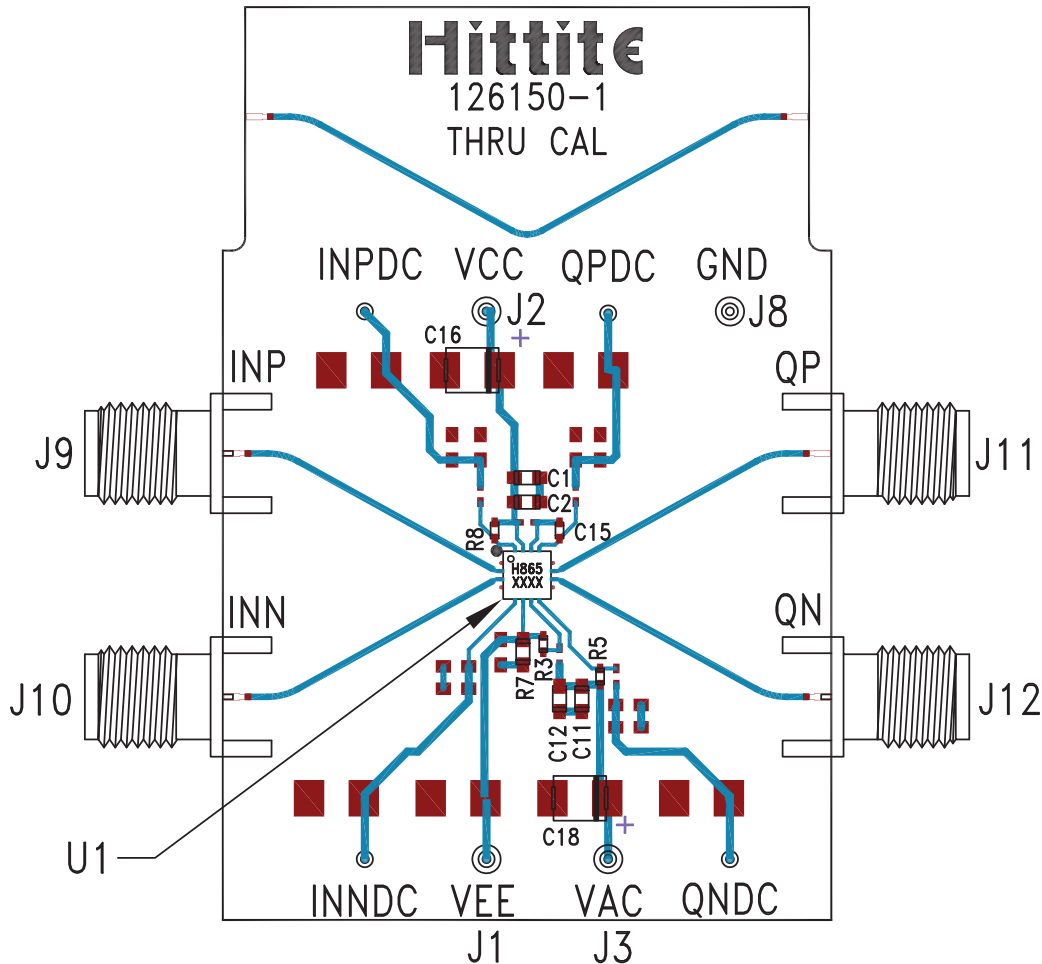

**List of Materials for Evaluation PCB 128123 [1]**

Item	Description
J1 - J3, J8	DC Pin
J9 - J12	K-type Connector
C1, C11	0.1 $\mu$ F Capacitor, 0603 Pkg.
C2, C12	1000 pF Capacitor, 0603 Pkg.
C15	0.1 $\mu$ F Capacitor, 0402 Pkg.
C16, C18	4.7 $\mu$ F Capacitor, Tantalum
R3, R5, R8	0 Ohm Resistor, 0402 Pkg.
R7	0 Ohm Resistor, 0603 Pkg.
U1	HMC865LC3C Limiting Amplifier
PCB [2]	126150 Evaluation PCB

[1] Reference this number when ordering complete evaluation PCB

[2] Circuit Board Material: Arlon 25FR or Rogers 4350

The circuit board used in the application should use RF circuit design techniques. Signal lines should have 50 Ohm impedance while the package ground leads and exposed paddle should be connected directly to the ground plane similar to that shown. A sufficient number of via holes should be used to connect the top and bottom ground planes. The evaluation circuit board shown is available from Hittite upon request.





32 Gbps LIMITING AMPLIFIER

Application Circuit

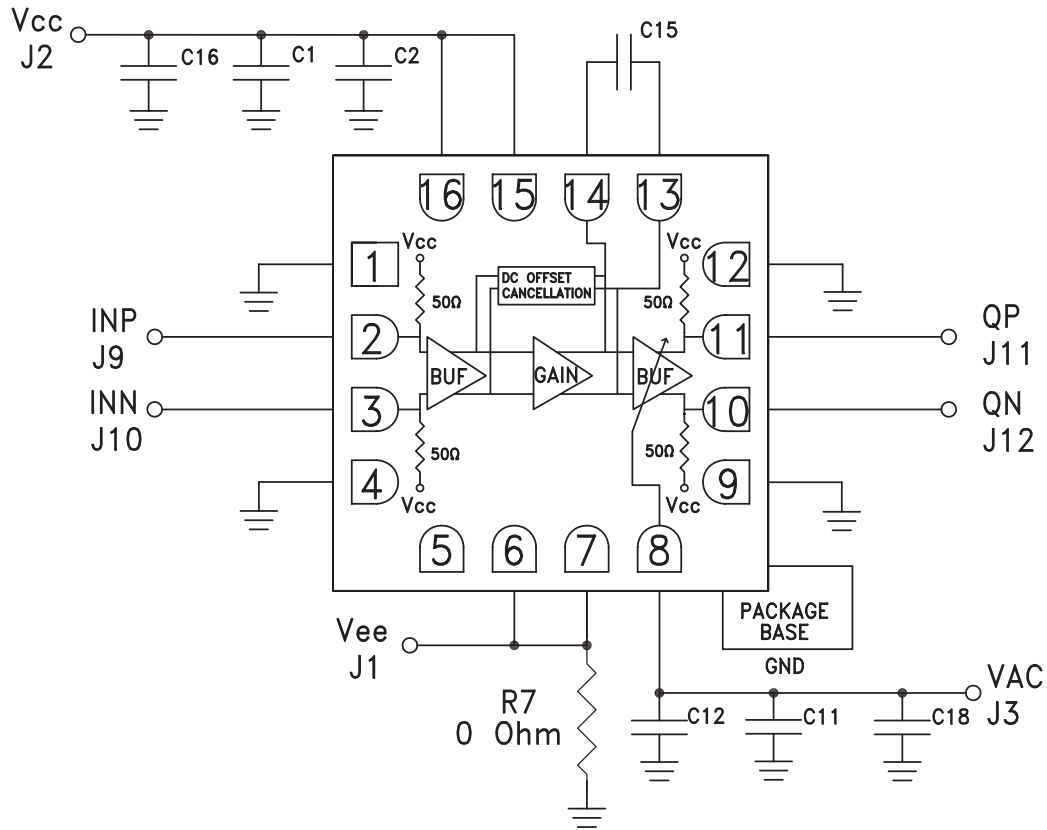

Component	Value
C2, C12	1 nF
C1, C11, C15	0.1 $\mu$ F
C16, C18	4.7 $\mu$ F



**Notes:**